

Carefully review complete instructions before beginning installation. These instructions are for installation with solid surface and composite material countertops. A professional installer is recommended to prevent damages to the sink or countertop during installation. Warranty void for improper installation and handling.

Handling

Be sure to wear personal safety devices such as safety goggles at all times.

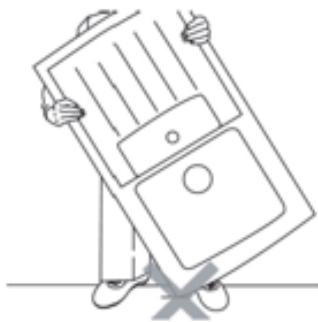

- Do not apply force to the corners

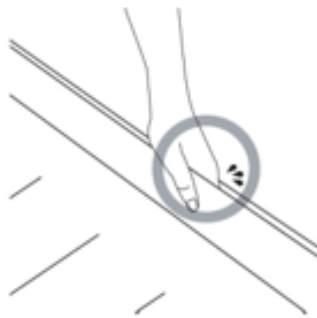

- Watch your hands

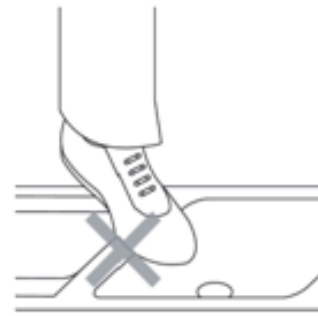

- Do not stand on the sinks 😊

Hole Additions

Faucet holes are predrilled from the bottom and marked yellow on top ledge. Tap the yellow marker only from the top. Use a screwdriver and center it in the middle of the hole and then hit it one with the hammer.

Please Do Not drill the hole with the hammer directly.



Topmount/Drop-in Installation

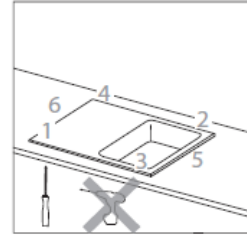
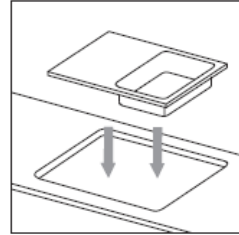
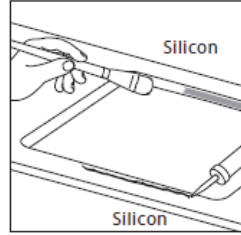
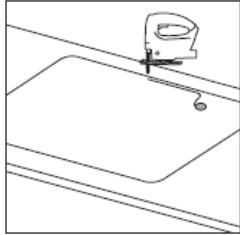

Topmount/Drop-in Installation
Mounting and fastening clips

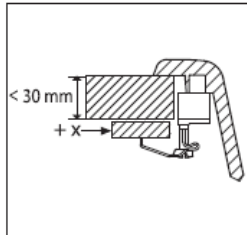
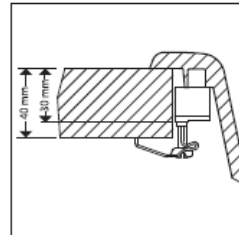
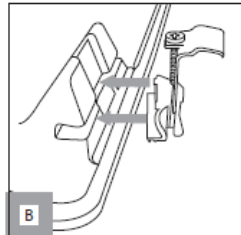
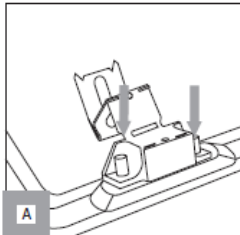

Flush Mount Installation

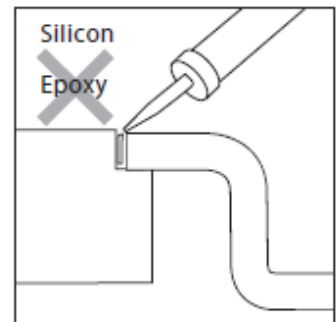
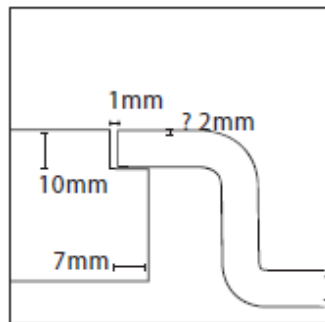
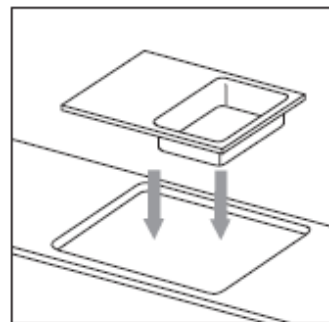

Undermount Installation

